



1100 Data Sheet



SERIES: 1000 WOOD GRILLES

STYLE: 1100 CROSS PIECE GRILLE

Overview

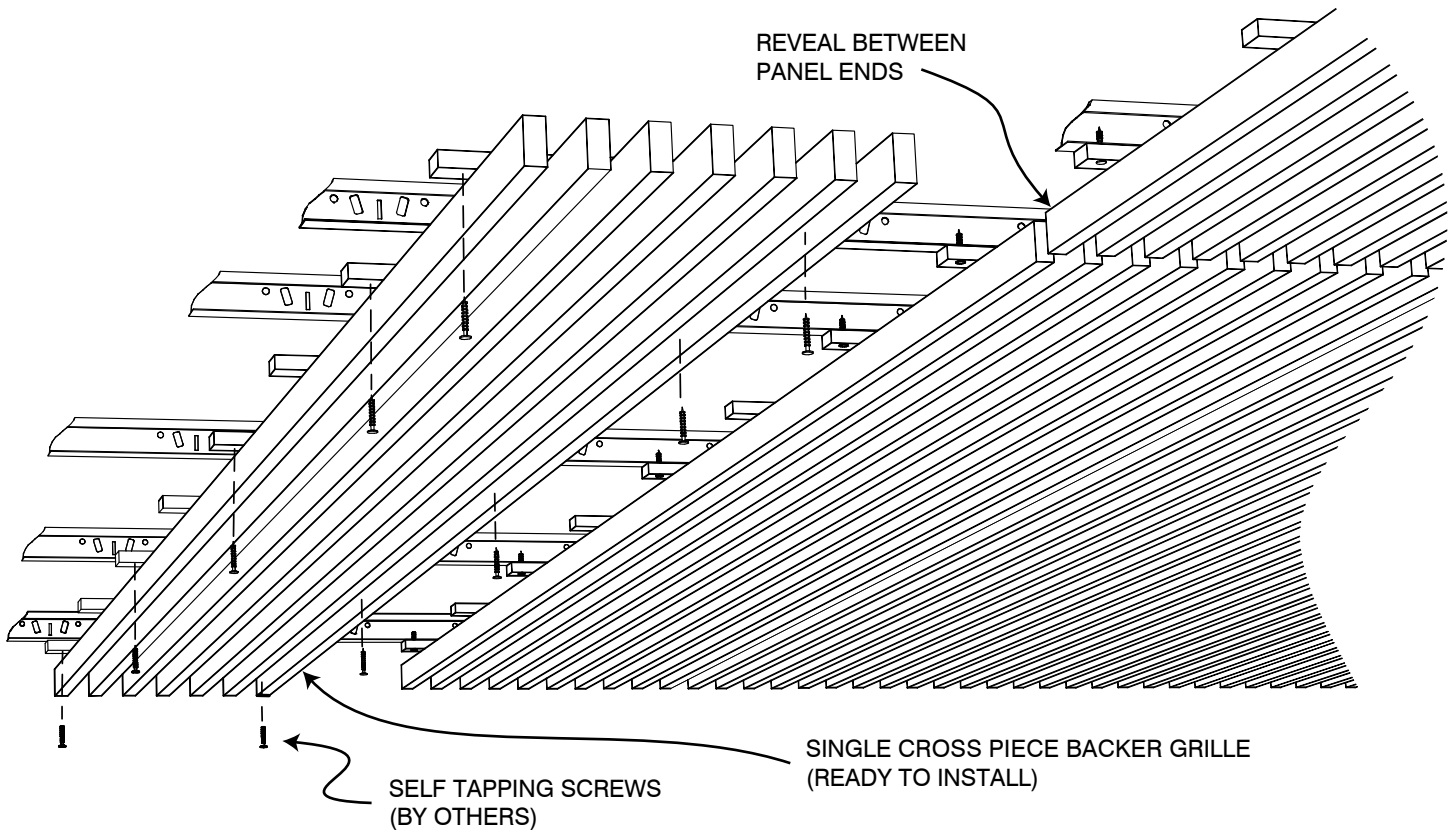

The **9Wood Cross Piece Grille** wood ceiling offers a design where the individual wood member is deeper than it is wide. The standard panel width is 12". Standard panel lengths are 4' through 10' for solid wood, or 8' for veneers. Budget and application generally drive the decision between solid wood or veneer.

Attachment for the Cross Piece Grille is via screws fastened directly through the backer into standard T-Bar grid. This provides basic accessibility for each panel.



1100 Data Sheet



SERIES: 1000 WOOD GRILLES

STYLE: 1100 CROSS PIECE GRILLE

Product Data

Application

The Cross Piece Grille uses a pre-assembled panel fabrication process. This product can be installed throughout the country and is the preferred design in areas requiring seismic compliance. Full panel access is available by means of removing attachment screws hidden in reveals. Repeated removal requires threaded 9Wood Caddy-Lock attachment as opposed to screws.

Performance

Acclimatization

Cross Piece Grilles must be cared for in a controlled interior environment (RH 25%-55% max; temp. 60°-80°) and installed only after reaching equilibrium moisture content. Should the building fall outside these limits consult 9Wood, Inc. for our 3 Tests/3 Tracks Acclimatization Advisory.

Acoustics

The Cross Piece Grille can enhance acoustics via sound absorbing material placed over open reveals within the T-Bar grid. Insulation is typically provided locally.

Fire Rating

Individual members and components can be treated with Class I (A) Fire Retardant chemicals (solid wood use FR coatings, veneered particleboard use FR formulas). Particular species or styles have not been tested.

LEED

Cross Piece Grilles may qualify toward MR-3, MR-4.1/4.2, MR-5.1/5.2, MR-6, MR-7, IEQ-4.2 or IEQ-4.4. As all products are custom-fabricated, LEED credit opportunities are project by project. Please contact 9Wood, Inc. for specifics.

MEP

The Cross Piece Grille permits MEP penetrations in the ceiling's surface. Cut panels may require supplemental reinforcement. Fixtures and diffusers must be independently supported.

Seismic

Cross Piece Grilles provide seismic code compliance by means of mechanical direct screw attachment to T-Bar via the cross-piece backer. Please consult local code or a licensed engineer for any additional requirements.

Species & Finishes

9Wood can offer both domestic and imported species for the Cross Piece Grille. Clear, matte sheen finish is standard; custom color matches and opaque finishes are available.

Suspension

Cross Piece Grilles are directly attached to 15/16" heavy duty T-Bar main runners. Main runners are installed 2' on center, depending on panel weight.

System Weight

Cross Piece Grilles typically weigh 2-4 pounds per square foot, depending on members per linear foot and species.



1100 Data Sheet



SERIES: 1000 WOOD GRILLES

STYLE: 1100 CROSS PIECE GRILLE

Typical Specifications

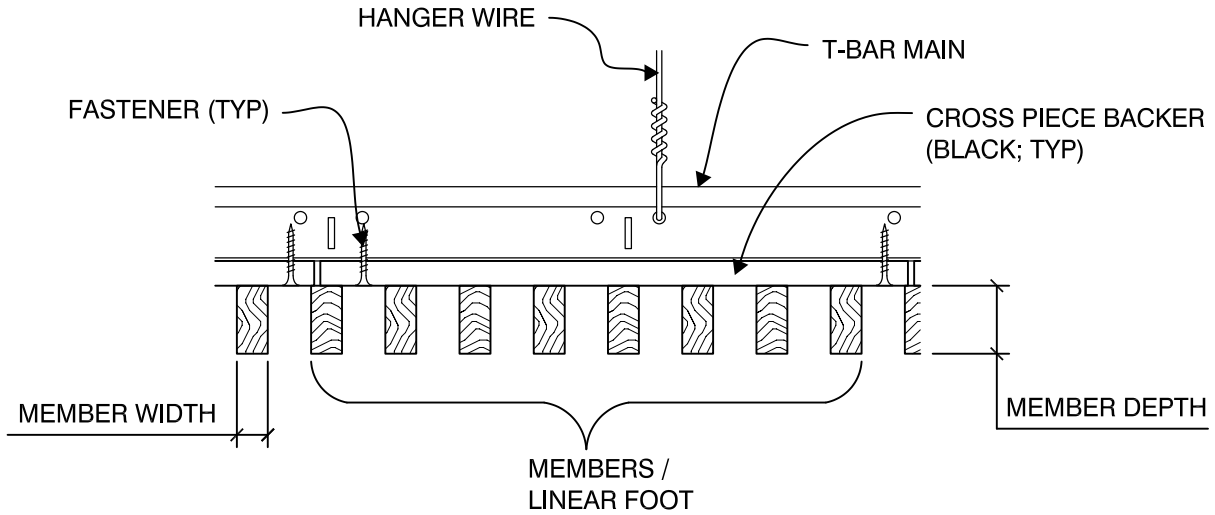

SKU Table

Width (Solid)	Width (Veneer)	Depth	Grille Members per Linear Foot							
			2	3	4	5	6	7	8	
5/8" or 3/4"	3/4" or 1"	1 3/8"	1112-2	1112-3	1112-4	1112-5	1112-6	1112-7	1112-8	
5/8" or 3/4"	3/4" or 1"	2 1/4"	1113-2	1113-3	1113-4	1113-5	1113-6	1113-7	1113-8	
5/8" or 3/4"	3/4" or 1"	3 1/4"	1114-2	1114-3	1114-4	1114-5	1114-6	Additional options may be available. Please check with 9Wood if you don't see the combination that you have in mind.		
3/4"	3/4" or 1"	5 1/4"	1116-2	1116-3	1116-4	1116-5				
1 3/8"	1 7/16"	1 3/8"	1122-2	1122-3	1122-4	1122-5				
1 3/8"	1 7/16"	2 1/4"	1123-2	1123-3	1123-4					
1 3/8"	1 7/16"	3 1/4"	1124-2	1124-3	1124-4					
1 3/8"	1 7/16"	5 1/4"	1126-2	1126-3						

Additional width, depth, and M/LF options may be available. Please check with 9Wood if you don't see the combination that you have in mind.



Perimeter Conditions and Suspension

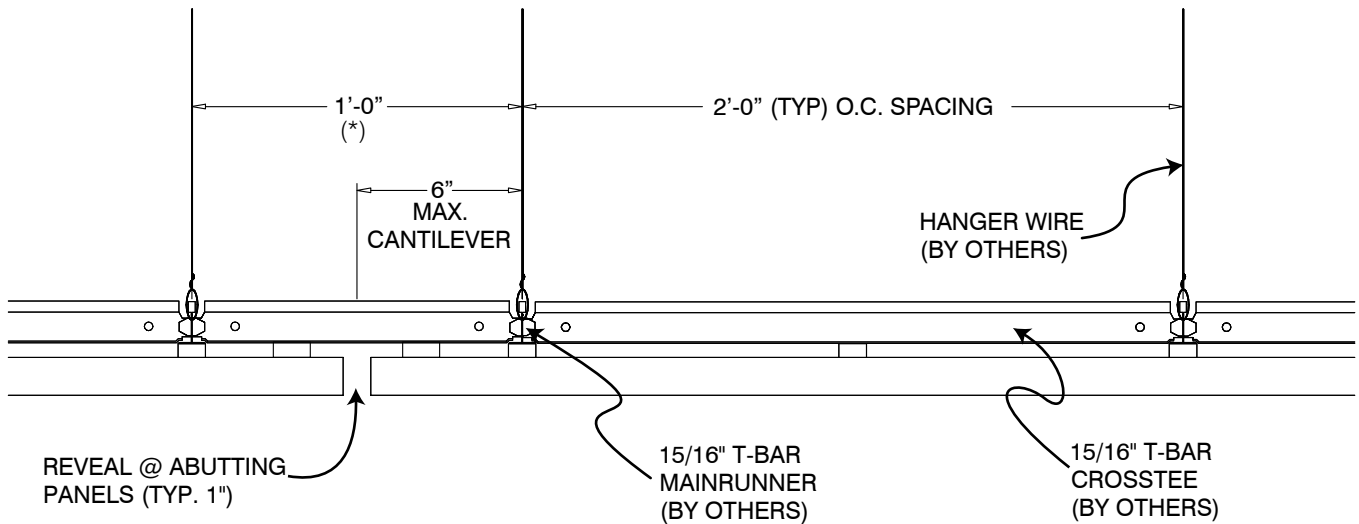

(*NOTE: A CENTER REVEAL TYPICALLY REQUIRES A CUSTOM OC SPACING IN THE SUSPENSION SYSTEM.

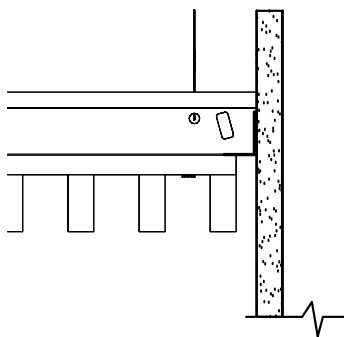

FLOATING:
OPEN REVEAL

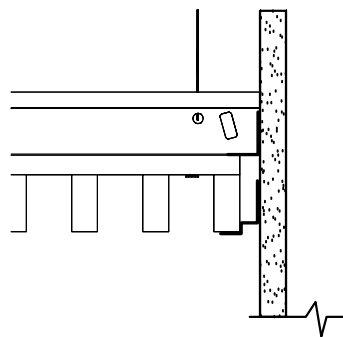

METAL TRIM:
CONT. SHADOW STYLE
WALL ANGLE

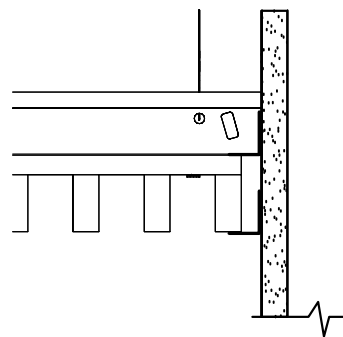

METAL TRIM:
CONT. WALL ANGLE

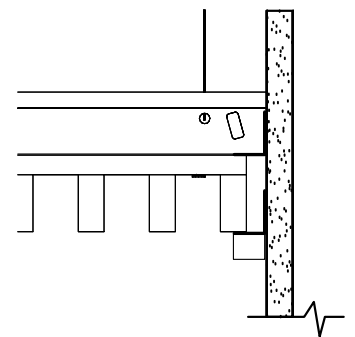

WOOD TRIM:
CONT. WALL ANGLE
W/WOOD TRIM